













Instructivo de Ensamblado Silla Ejecutiva Luxemburgo

A		x1
B		x1
C		x5
D		x1
E		x1
F		x2
G		x1

I		M6x20	x4
J		M6x30	x6
K		M6	x10
M		M5	x1
N		M8x20	x2

1** Nota Importante: en caso de que el pistón traiga una tapita de plástico (El color puede variar) Sólo se retira fácilmente, no necesita herramienta en caso de no traerlo favor de no forzar ni quitar piezas del pistón, después de esto, podrá ensamblar el pistón al mecanismo

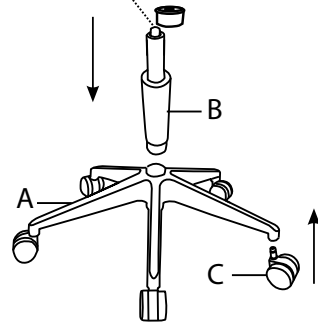

2 Coloque los brazos al respaldo a los tornillos 8x 20 mm (2 pz)



3 Coloque los brazos al asiento con las rondanas y tornillos 6x 30 mm (6 pz)

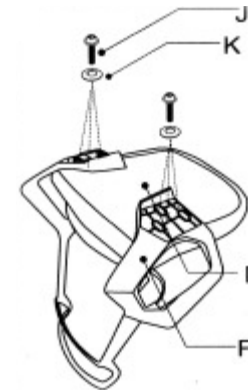

4 Coloque el mecanismo al asiento los tornillos 6x20mm (4 pz)

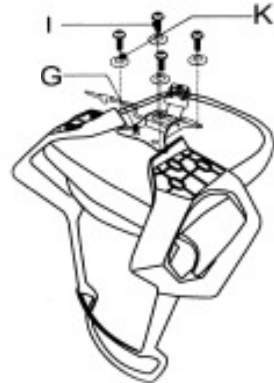

5 Ensamble el asiento y respaldo previamente armado a la base y pistón.



**Nota importante:

La tornillería puede variar dependiendo el que se envíe de fábrica en el paquete, las rondanas son opcionales dependiendo el tornillo que venga de fábrica para el ensamblado.