

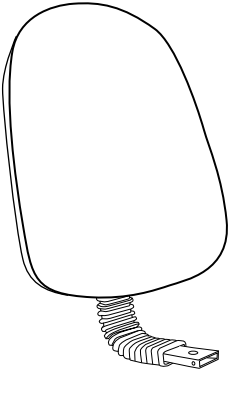



Instructivo de Armado Silla Cajera Venus

<p>Respaldo (1 pza)</p> 	<p>Asiento (1 pza)</p> 	<p>Mecanismo fijo (1 pza)</p> 
	<p>Pistón (1 pza)</p> 	<p>Aro Nylon (1 pza)</p> 
<p>Base Nylon (1 pza)</p> 	<p>Rodaja (5 pzas)</p> 	<p>Placa plana (1 pza)</p> 
<p>Tornillo M6 x 25 mm (4 pzas) Asiento B</p> <p>Tornillo M6 x 20 mm Respaldo (4 pzas) A</p> 	<p>Perilla de ajuste (1 pz)</p> 	<p>Gusano (1 pza)</p> <p>Barra (1 pza)</p> 

Nota Importante:
En caso de que el pistón tenga esta tapita de plástico (El color puede variar) Sólo se retira fácilmente, no necesita forzar, ni herramienta, en caso de no traerlo favor de no forzar ni quitar piezas del pistón. Después de esto puede ensamblar el pistón en el mecanismo.

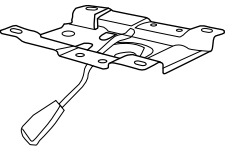
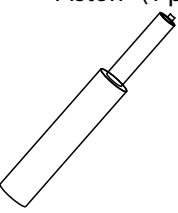

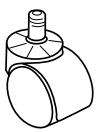
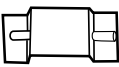
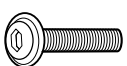
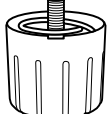
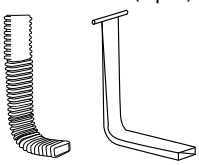
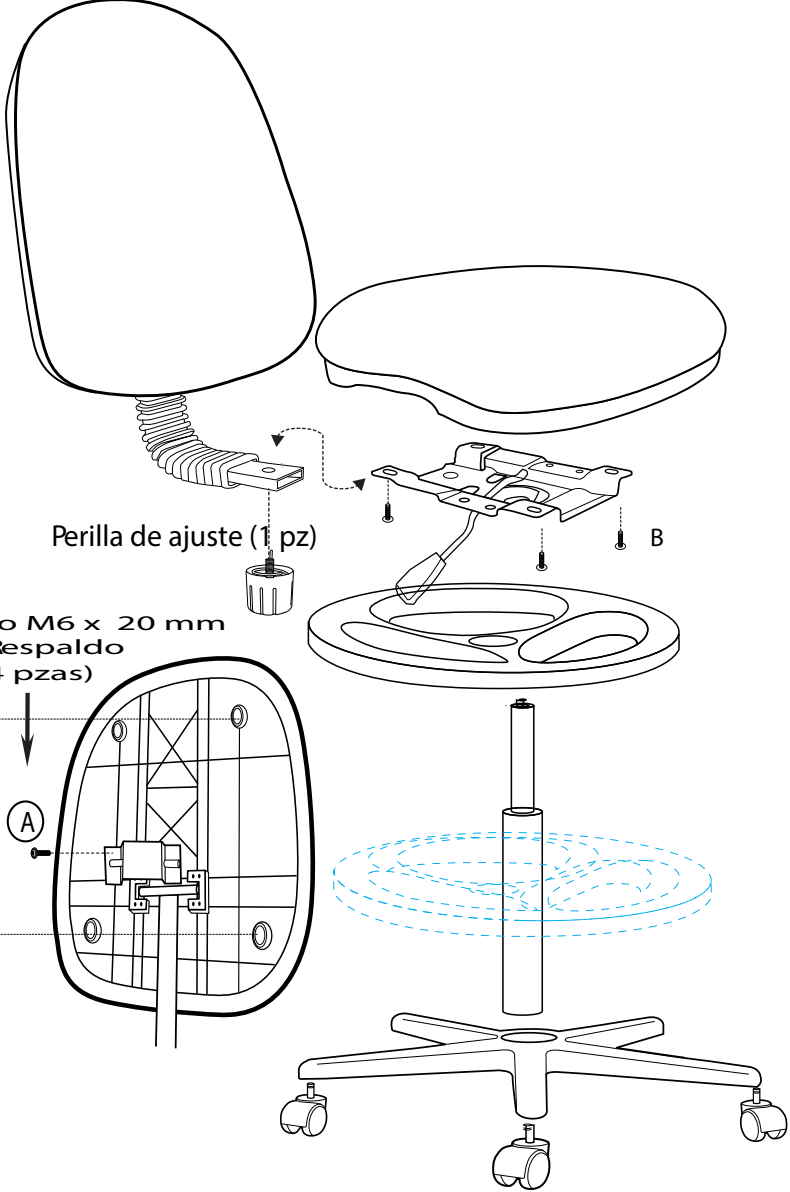
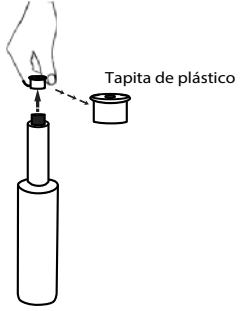
Nota importante:
La tornillería puede variar dependiendo la que se envíe de fábrica en el paquete, las rondanas son opcionales, dependiendo el tornillo que venga de fábrica para el ensamblado.